

TRIAC dimmable constant voltage led driver



Features特征:

- The output voltage is constant.输出模式: 恒压
- Fir for trailing&leading edge dimmers.兼容前沿/后沿调光
- Using active built-in PFC techology.采用PFC技术
- Efficiency>83% PF>0.90.效率>83%功率因素PF>0.90
- Protection:SCP/OVP.短路保护 过压保护
- Fireproof PC design.阻燃塑料外壳设计
- Easy to install.容易安装
- Nature cooling.自然冷却
- CE/ROHS/SAA/TUV passed.CE/ROHS/SAA/TUV认证
- 5 Years warranty.5年质保

规格书Specification Sheet

名称Model	恒压源CV	MSD-DIM-CV-60W	
输出 Output	输出电压 Output Voltage	12V	24V
	恒流精度 Current Precision	±5%	
	输出电流 Output Current	4000ma	2500ma
	输出功率 Output Power	48W	60W
	线性调整率Line Regulation	1%	
输入 Input	输入电压 Input Voltage Range	AC 100-140V or 180-240V	
	输入电流 AC Current(Typ)	0.69A@100VAC 0.57A@120VAC 0.32A@220VAC 0.28A@240VAC	
	频率 Frequency Range	47-63Hz	
	功率因数 PFC(Typ)	>0.95@full load	
	效率 Full-loading Efficiency	>80%@full load	>85%@full load
异常保护 Protection	保护类型 Short Circuit	Short circuit protection / Over voltage protection	
	最大输入电压Over Voltage	<265VAC	
使用环境 Environment	工作温度Operation Temperature	-25~+50℃	
	工作湿度Operation Humidity	20~90%	
	存储 Storage	-40~ +85℃, 10~95%RH	
	温度系数Temperature Coefficient	±0.03%/℃(-45~50℃)	
	抗震能力Vibration Resistance	10~500HZ,2G 10Min/period,X、Y、Z line per 60 mins	
安规与电磁兼容 Safety&EMC	标准 Standard	Refer to EN-60950-1	
	耐压 Withstand Voltage	I/P-O/P:3.75KVAC	
	绝缘强度Insulating Strength	I/P-O/P:400M Ω/500 VDC/25℃/70%RH	
	传导 EMC Emission	To Correspond EN55015,EN61000-3-2(≥50% load)	
	辐射 EMC Immunity	To Correspomd EN55015,EX61000-4-2,3,4,5,6,8,11,A Level of light industry standard(Surge 4KV)	
其他Other	重量Weight	200g	
	尺寸Dimension	170*50*31mm (L*W*H)	
	PCB材质	94V-0 PC fire retardant	
	颜色Color	Dark Grey	
	包装Packing	44*28*18cm/20pcs	

NOTE

All parameters are measured at normal temperture(25-28℃)  
 1、Ripple & Noise are measured at 20KHz of bandwidth by using a 12" twisted pair-wire teminated with a 0.1 uf & 47uf parallel capacitor(@ full load).  
 2、The efficiency measured at Max output voltage,and 230VAC with full load,if with 110VAC the efficiency will be lowered 0.5%~1.5%;Working 1~2 hours,efficiency will be higher 1.5%~1%than the initial stage.

TRIAC dimmable constant voltage led driver

1.Dimension

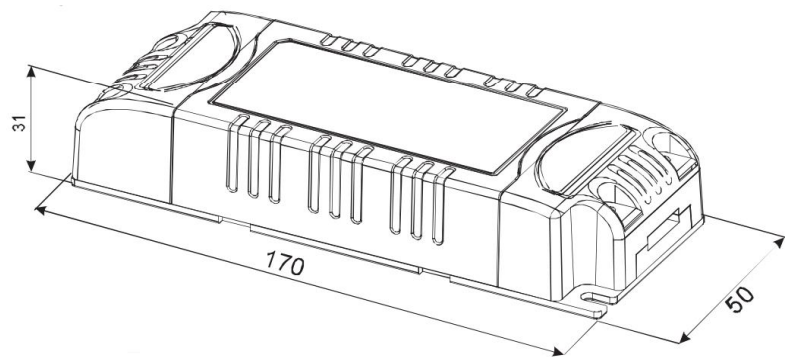

2.Wiring diagram

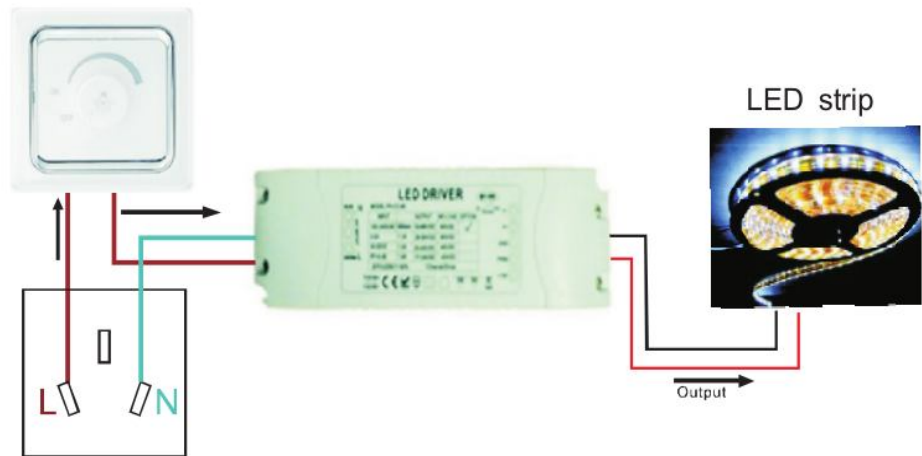

3.Power Factor & THD Characteristics

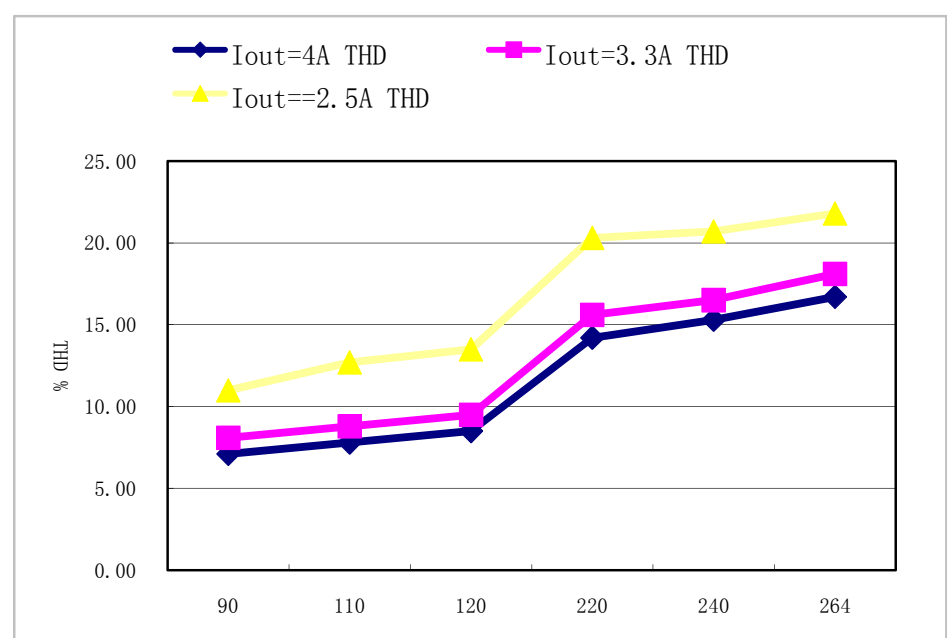
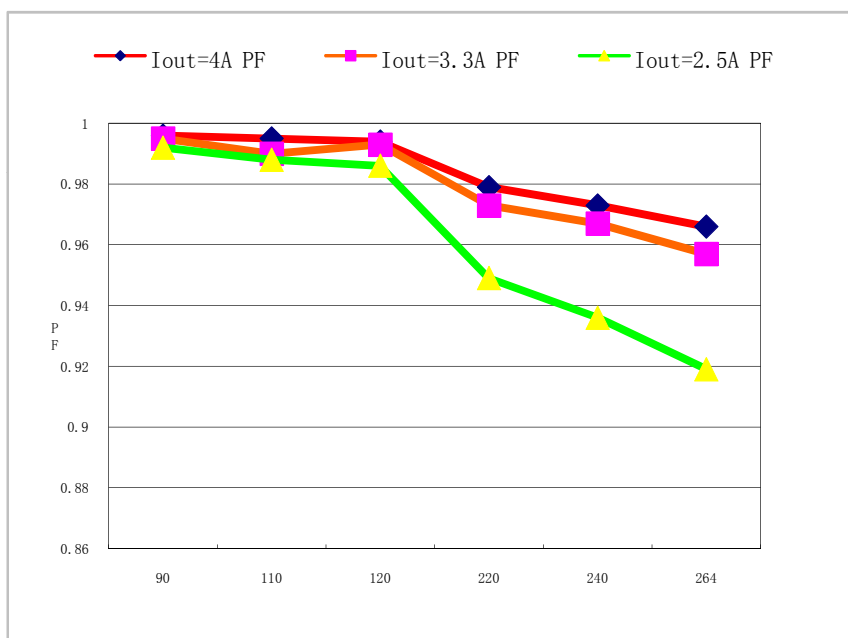

4.Efficiency & Load of (110VAC / 230VAC)

